

LED 1 between 1 (A) and 10 (K)
LED 2 between 2 (A) and 10 (K)
LED 9 between 9 (A) and 10 (K)

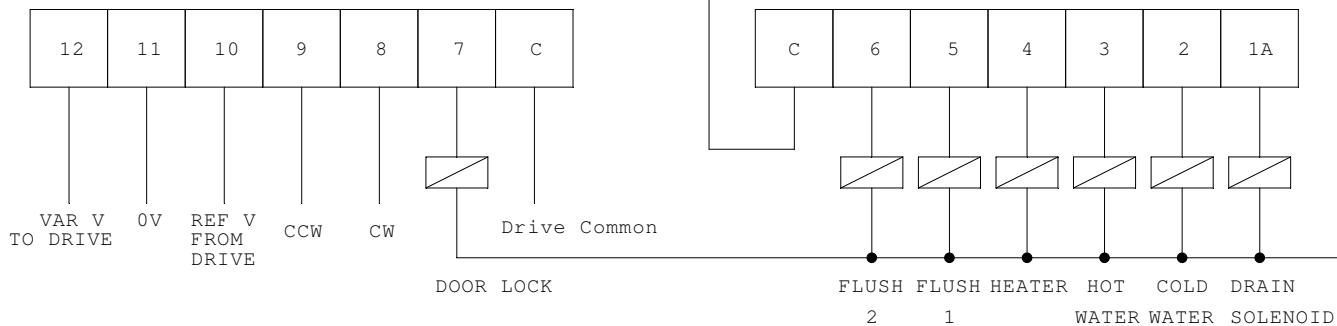

Title	PLC	V19.x	P19.x
Company	BK Electronics cc		
Author	B Kok		
Size	C		Revision
Date:	February 28, 2006	12:22:00	Sheet of